

ACT-AC-P

Operation manual



CONTENTS

NO.1 Design Specification	P1-7
Internal Connection Note	
NO.2 Software operation	P8-13
Preoperation inspection Power on the equipment System configuration	
NO.3 Equipment debugging	P16-23
Main interface Management configuration interface About business card printing	Service optional
NO.4 Charging operation	P22-34
Online Version Single Mode Reservation Mode Plug and Charge	
NO.5 Common problems and solutions of charging pile	P35-37

01

Design Specification

- 1.1 Internal Connection
 - 1.1.1 Input Wiring Steps
- 1.2 Note
 - 1.2.1 Connection Mode

Use of
Charging Pile

Item	Specification			
Name	POWER	AC 7kW	AC 11kW	AC 22kW
	Temperature	-30°C to +55°C		
Environment	Humidity	5% to 95% no congeal		
	Altitude height	2000m		
	Noise control	less than 30db		
	Size	22*29*10 cm		
Electrical	Input voltage	1/N/PE ~ 230V	3/N/PE ~ 380V	3/N/PE ~ 380V
	Input frequency	50Hz		
	RCD	Type A+AC 30mA		
	Electric relay specification	50A 250VA		
	Rated Output	max output 32A	max output 16A	max output 32A
	Cable Length	5 meter output cable, no input cable in default		
Structure	Charging Method	RFID(Optional) card / plug and charge /APP/ Reservation charging		
	Application	Indoor/Outdoor		
Optional Function	Load Balance	CT+Single/Three Phase Meter		
	OCPP	4G/Ethernet		
	Screen	Screen is removable if not needed		

illustrate: Please refer to the actual purchased machine. Not all are provided.

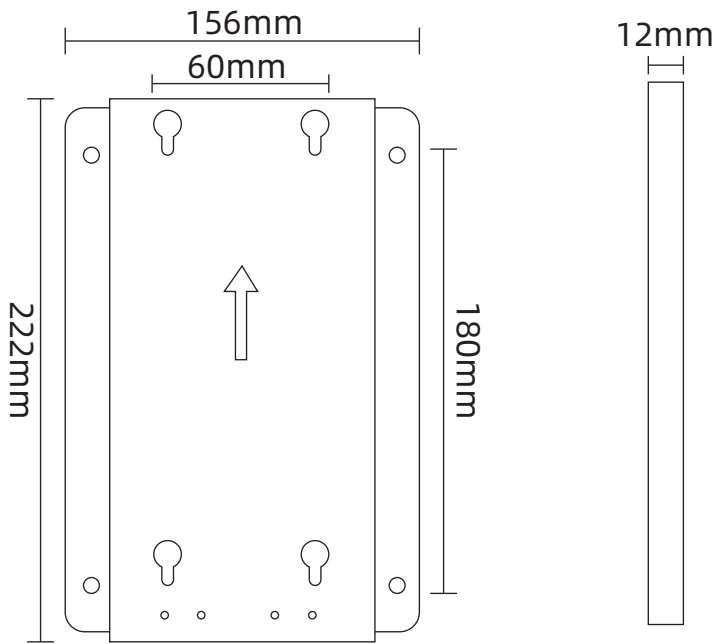

1.1 Internal Connection

1.1.1 Input Wiring Steps

Step 1: Open the shell of the charging station and check the input interface of the circuit board. The image without wiring is as follows.

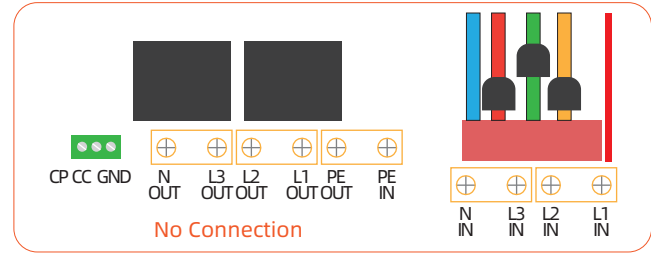

Step 2: Check the prefabricated input cable and confirm that the phase correspondence is correct.

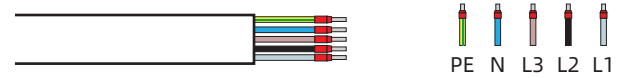

Step 3: Check the prefabricated input cable and confirm that the phase correspondence is correct.

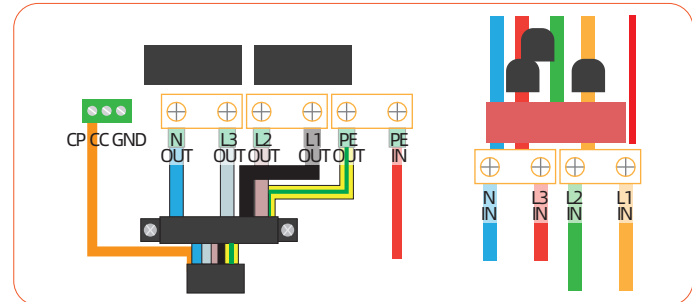

NOTE:

Just connect L1 wire for single phase ev charger.

1.2 Note

After Wiring is Completed:

- 1) Tighten the screws at the wiring point, gently pull them out without loosening;
- 2) Some wires are reserved inside the junction box of the Charging station to prevent the wires from extra tension;
- 4) The cables at the input end and output end shall be kept vertical outside the Charging station;
- 7) Confirm that the rear cover of the Charging station housing is correct.
- 6) Check again if there are any abnormalities at each wiring point;
- 3) Excess wires can be properly bent and neatly organized;
- 5) Tighten the external fasteners of the input and output terminals clockwise;
- 6) Check again if there are any abnormalities at each wiring point;
- 7) Confirm that the rear cover of the Charging station housing is correct.

1.3.4 Connection Mode

1.Normal Connection



2.Connection by External Metering

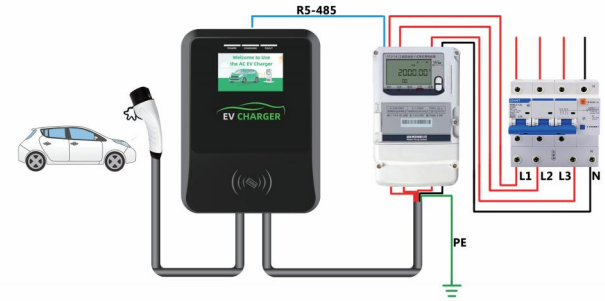

3.Connection by Load Balancing

By CT

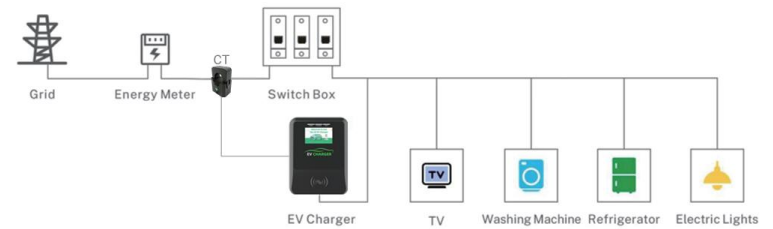

By Electric Meter

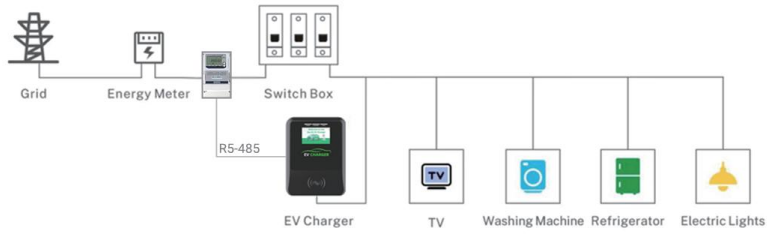

By Wireless CT

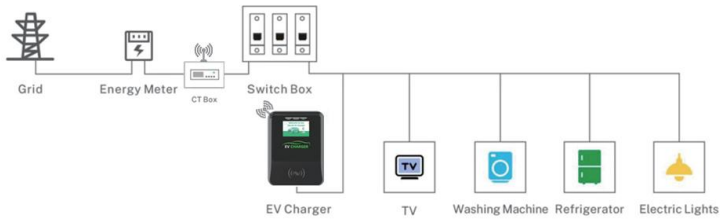

Dynamic Load Balancing

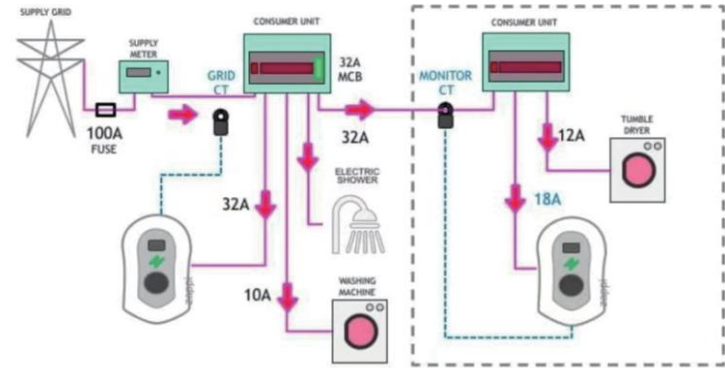

02

Equipment debugging

- 2.1 Preoperation inspection
- 2.2 Power on the equipment
- 2.3 System configuration
 - 2.3.1 Add device
 - 2.3.2 Equipment configuration

Use of
Charging Pile

2.1 Preoperation inspection

Before operation, please carefully check and ensure the following items:

- The installation location of the charging pile is convenient for operation and maintenance;
- The charging pile is correctly connected to the accessories and installed firmly;
- The selection and installation of AC incoming leakage protection circuit breakers are reasonable;
- The charging pile accessories are complete and the charging gun is in the hung state.

2.2 Power on the equipment

After all pre-operation inspection items meet the requirements, close the power supply inlet leakage protection circuit breaker, and observe the status of the LED indicator light after power-on is complete.

Normal standby: green light is always on

Charging status: blue light is always on

Equipment fault: red light is always on

2.3 System configuration

After the charging pile is powered on normally, configure the relevant parameters through the mobile phone APP, download the "Smart Life" APP from the mobile phone mall, install it, open the APP, register and log in, and enter the APP configuration interface.

2.3.1 Add device

Open the app, log in, enter the add device interface, turn on your phone's WiFi and Bluetooth, search for charging pile devices, and click the add button after finding the device.

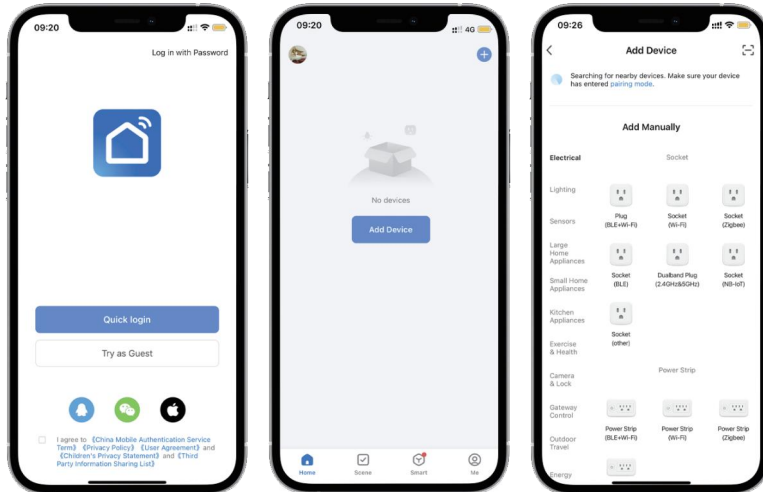

Click the Add button to jump to the WiFi configuration interface, select a good WiFi (try to choose 2.4GHz band), enter the password, click the Next button, enter the add interface, it takes about 1 minute, and then the add is completed.

NOTE:

If there is no WiFi on site, turn on the hotspot on your phone, and then connect another phone to this hotspot to configure the WiFi of the charging pile. Alternatively, you can configure it in a place with WiFi and ship it to the installation site.

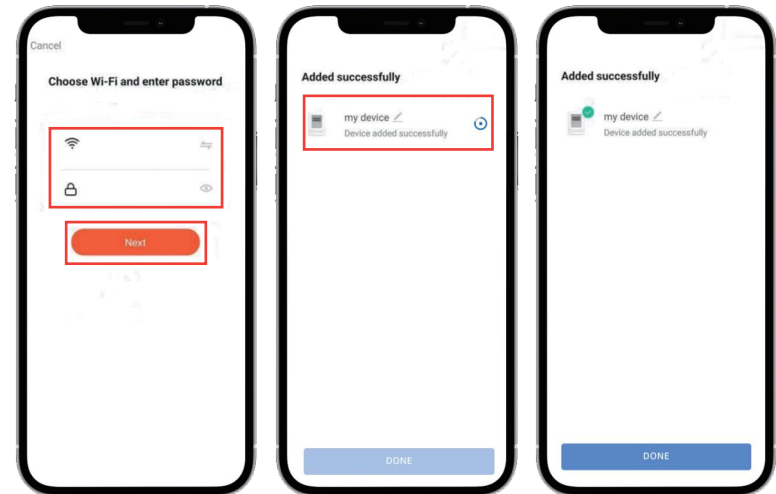

2.3.2 Equipment configuration

After adding the device, enter the charging pile data configuration and status display interface, which displays the voltage, current, charging capacity, amount, balance, charging status, pile code, etc. Click the authentication button in the lower right corner and enter the password 888888. After passing the authentication, enter the charging pile data configuration interface. There are three configuration buttons

below: communication data configuration, basic parameter configuration, and basic function configuration.

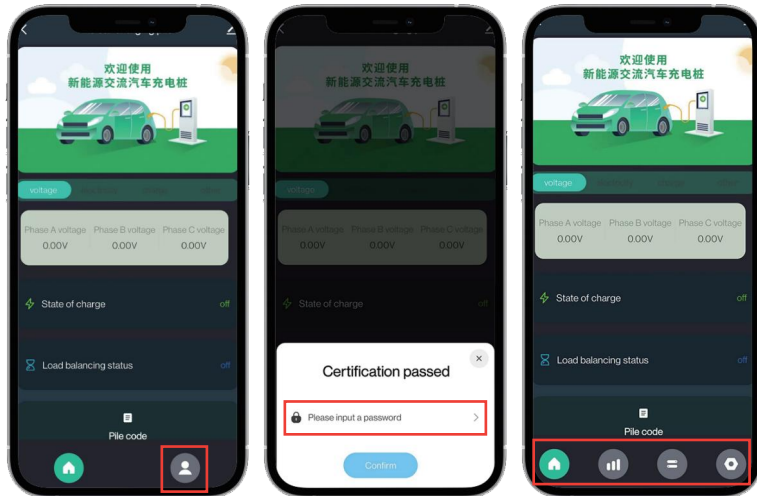

Communication data configuration: configure OCPP protocol, TLS encryption, APN, APN user name, APN user password;

Basic parameter configuration: configure the pile code (multiple piles with different names), device time, pile rated current, load balancing current, electricity card authorization, and QR code prefix;

Basic function configuration: configuration of charging mode, metering mode, grounding test, PEN protection, charging status, charging plan, and network mode.

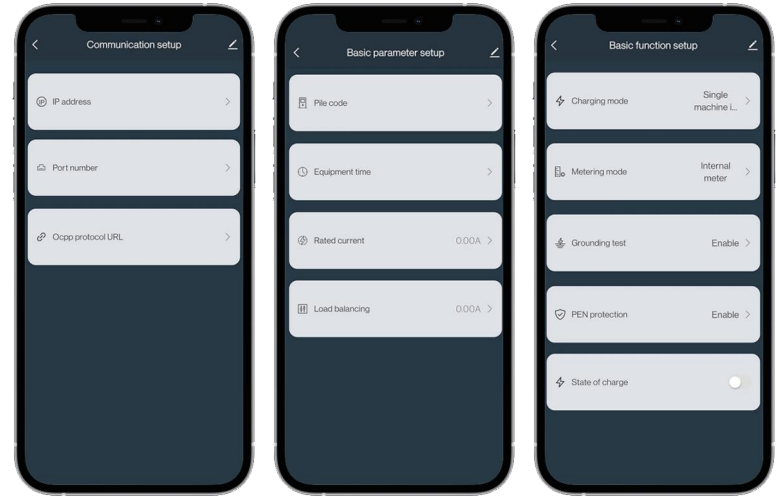

NOTE:

It is only necessary to configure the charging pile once for the APP. When you encounter the following situations, you need to reconfigure it:

- (1) The WiFi account or password connected to the device has been changed;
- (2) If you delete the device in the APP, you need to reconfigure it when reconnecting.

Service optional 03

Equipment debugging

3.1 Main interface

- 3.1.1 Charge Query
- 3.1.2 Record Query
- 3.1.3 Unlock Card

3.2 Management configuration interface

- 3.2.1 Administration entrance
- 3.2.2 Introduction to management configuration
- 3.2.3 Unlock Card

3.3 About business card printing

Use of
Charging Pile

3.1 Main interface

After the charging pile configuration is complete, restart the charging pile and enter the main interface of the single-gun charging pile, as shown in the figure;

function buttons: Charge Query, Record Query, Unlock Card. The bottom displays the name of the charging pile, the version number of the main program, and the version number of the screen program.



3.1.1 Charge Query

Click [**Charge Query**] to enter the Fee Details interface to view the unit price and service fee for the charging period.

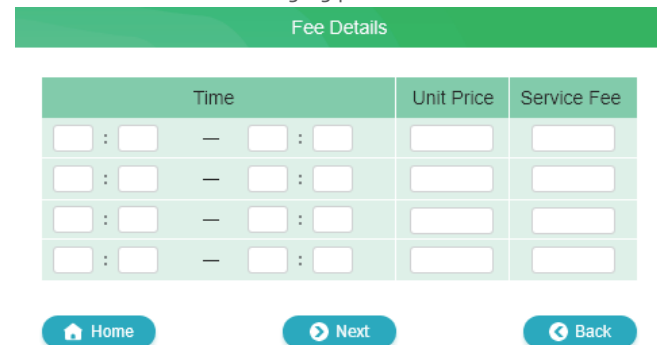

3.1.2 Record Query

Click **[Record Query]** to enter the Record Information interface and view the charging records in standalone mode (network mode, reservation mode, and plug-and-charge mode without recording). The record display content includes: Card Balance, Status (Settled after charging settlement, Unsettled if not settled, Settled if the unsettled order is settled by swiping the card), Electricity, Cost, Stop Reason, and the start and end time of charging.

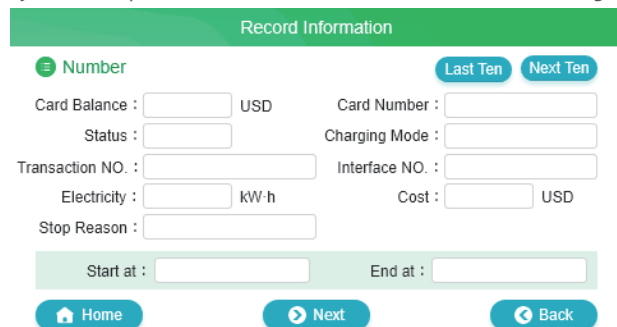

The screenshot shows the 'Record Information' interface. At the top is a green header with the title 'Record Information'. Below the header, there is a menu icon and the word 'Number'. To the right of this are two buttons: 'Last Ten' and 'Next Ten'. The main area contains several input fields: 'Card Balance : [] USD', 'Card Number : []', 'Status : []', 'Charging Mode : []', 'Transaction NO. : []', 'Interface NO. : []', 'Electricity : [] KW-h', and 'Cost : [] USD'. At the bottom, there are two more input fields: 'Start at : []' and 'End at : []'. At the very bottom, there are three buttons: 'Home', 'Next', and 'Back'.

3.1.3 Unlock Card

Click on 'Unlock Card' to enter the charging card unlocking interface. Place the charging card locked by this charging pile near the swiping area, and the prompt 'Unlock Success' will appear. Then, the charging card can be used normally.

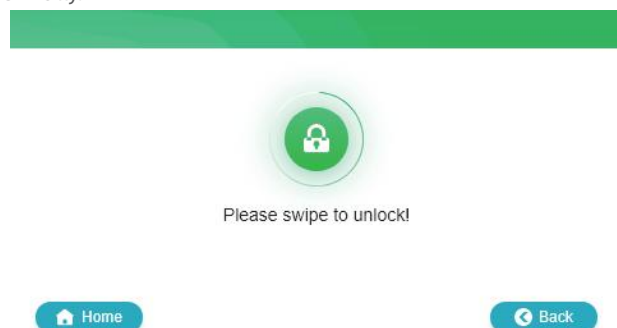

The screenshot shows the 'Unlock Card' interface. At the top is a green header with the title 'Unlock Card'. Below the header, there is a large circular icon with a green padlock and the text 'Please swipe to unlock!'. At the bottom, there are two buttons: 'Home' and 'Back'.

3.2 Management configuration interface

3.2.1 Administration entrance

Click on the upper right corner of the main interface to enter the management portal. The default password is 888888.

3.2.1.1 Change password

Click **[Password change]** to modify the administrator password.

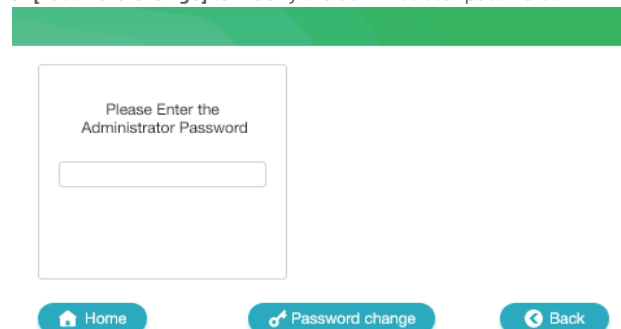

The screenshot shows the 'Change password' interface. At the top is a green header with the title 'Change password'. Below the header, there is a white box with the text 'Please Enter the Administrator Password' and a single input field. At the bottom, there are three buttons: 'Home', 'Password change', and 'Back'.

3.2.1.2 System Settings

At the management portal, enter the administrator password to access the System Settings interface and modify different functional parameters of the charging pile. Function buttons: Basic Parameter, Communication Data, Basic Function, Card Management System.

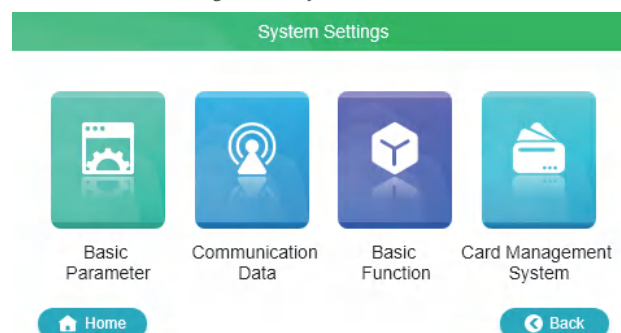

The screenshot shows the 'System Settings' interface. At the top is a green header with the title 'System Settings'. Below the header, there are four large icons representing different settings: 'Basic Parameter' (gear icon), 'Communication Data' (person with signal waves icon), 'Basic Function' (cube icon), and 'Card Management System' (card icon). Below each icon is its corresponding label. At the bottom, there are two buttons: 'Home' and 'Back'.

3.2.2 Introduction to management configuration

3.2.2.1 Basic parameter

On the System Settings interface, click Basic Parameter to enter the Basic Parameter Configuration interface, where you can modify and set relevant parameters:

Charger No.: Set the name of the charging pile;

Installation Time: Set the charging pile time;

Charger Rated Current: The minimum rated operating current is 9A and the maximum is 32A;

Load Balancing Current: Load balancing current;

Gun Meter Number: external meter address, used to access external meters;

Management Address: The platform address, used to connect to the user platform;

Local Address: used for 485 communication to fill in the address.

Basic Parameter Configuration

Charger NO. :

Installation Time : / / - : :

Charger Rated Current :

Load Balancing Current :

Gun Meter Number :

Management Address :

Local Address :

[Home](#) [Back](#)

3.2.2.2 Communication Data

On the System Settings interface, click **[Communication Data]** to enter the Communication Data Configuration interface, where you can modify the relevant parameters:

WiFi Name: WiFi networking is used locally;

WiFi Password: Enter the correct password;

URL: the platform address of OCPP;

APN, APN Name, APN Password: Edit and fill in according to the information provided by the operator.

Communication Data Configuration

WiFi Name :

WiFi Password :

URL :

APN :

APN Name :

APN Password :

[Home](#) [Back](#)

3.2.2.3 Basic Function

In the System Settings interface, click [Basic Function] to enter the Basic Function Configuration interface, which is mainly divided into four charging modes: Online Version, Single Mode, Reservation Mode, and Plug and Charge. For detailed operation, see the "Charging Operation" section below.

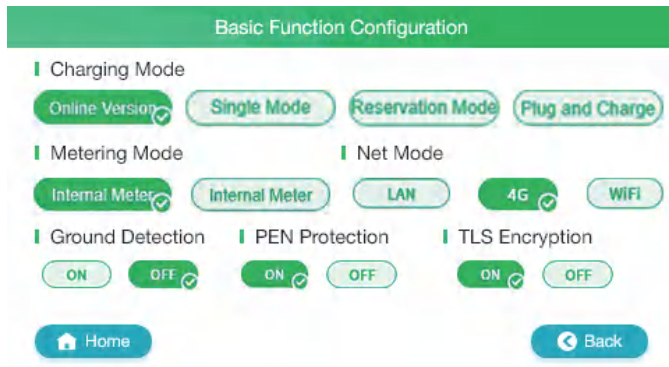

3.2.2.4 Card Management System

On the System Settings interface, click [Card Management System] to enter the Card Management System interface. Here, card binding or key only takes effect in stand-alone charging mode. If a card is already bound, only the bound card can be used for charging. If a card is not bound, the key card can be charged normally.

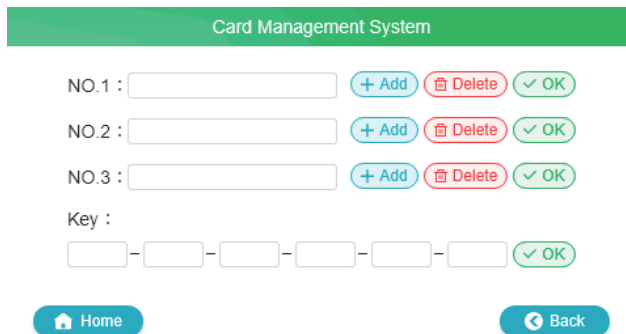

3.3 About business card printing

Our company has professional business card printing tools. The following figure shows our business card printing software and card reader. You can use the business card printing tools to view and set up charging cards: business card printing keys, recharge, user management, card issuing records, recharge records, and more.

Click on the upper right corner of the main interface to enter the management portal, enter the administrator password, and then click on "Basic Function" to enter the Basic Function Configuration interface. The specific operation of the charging mode is as follows:

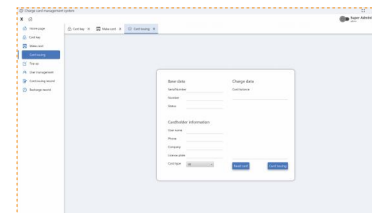
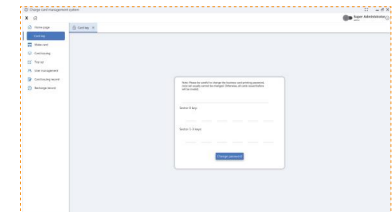

04

Charging operation

- 4.1 Online Version
 - 4.1.1 LAN mode
 - 4.1.2 Start charging
 - 4.1.3 Stop charging
 - 4.1.4 4G mode
- 4.2 Single Mode
- 4.3 Reservation Mode
 - 4.3.1 Starting charging
 - 4.3.2 Stop charging
- 4.4 Plug and Charge

Use of
Charging Pile

4.1 Online Version

4.1.1 LAN mode

First, in the Basic Function Configuration interface, configure the following parameters, and fill in the network platform address in the URL of the Communication Data Configuration interface. Restart the charging pile (rebooting the device is required to modify the charging mode). After checking the online success of this charging pile on the network platform, start charging.

NOTE:

The charging card used in the network mode must be added to the network platform as an authenticated card.

Charging Mode: Online Version;
Metering Mode: Internal Meter (without external meter connection),
External Meter (with external meter connection);
Net Mode: LAN;
Ground Detection: select ON;
PEN Protection: select ON;
TLS Encryption: Select ON.

4.1.2 Start charging

In the state of gun insertion, click Gun A or Gun B on the main interface, and a QR code will appear. After swiping the card, charging will begin.

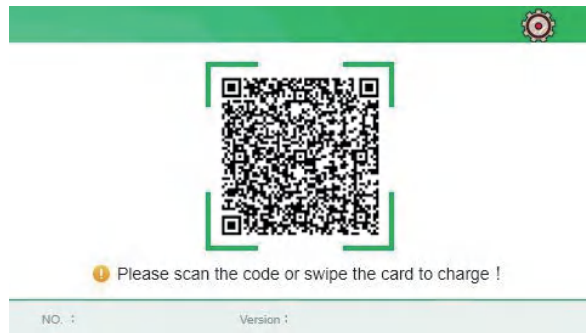

In the charging interface, the screen displays the current, voltage, power, charging amount, charging amount, balance in the card, rated current, rated load balancing current, and actual load balancing current during charging.

In the network mode, charging gun can be controlled remotely through the network platform to start charging.

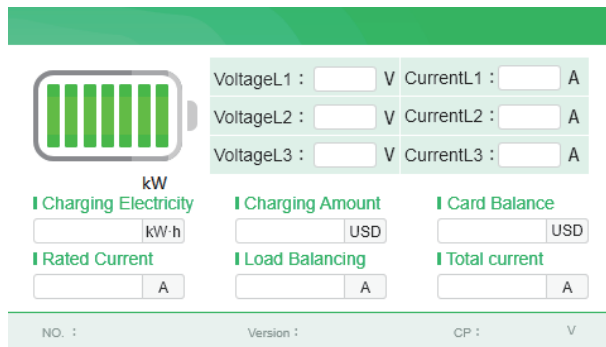

4.1.3 Stop charging

There are several ways to stop charging in network mode:

Card swiping starts charging, and swiping again stops charging;

Stop charging through the network platform;

When full, stop.

4.1.4 4G mode

This mode is configured the same as the LAN mode. Please select 4G in Net Mode, fill in the APN related parameters in the Communication Data Configuration interface (edited according to the information provided by the operator), restart the charging pile (rebooting the device is required to modify the charging mode), and then start charging (the same as starting and stopping charging in the LAN mode).

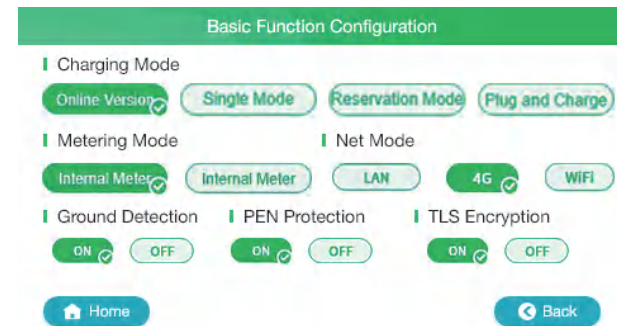

4.1.5 WiFi mode

This mode is configured the same as the LAN mode. Please select WiFi in Net Mode, fill in the WiFi Name and WiFi Password in the Communication Data Configuration interface (the WiFi signal near the charging pile must be stable and good), restart the charging pile (rebooting the device is required to modify the charging mode), and then start charging (the same as starting and stopping charging in the LAN mode).

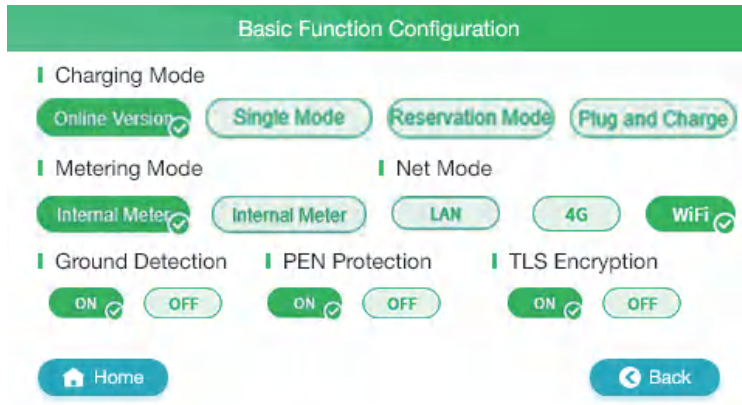

4.2 Single Mode

First, in the Basic Function Configuration interface, configure the following parameters, and then restart the charging pile (rebooting the device is required to modify the charging mode).

Charging Mode: Single Mode;

Metering Mode: Internal Meter (select when not connected to an external meter), External Meter (select when connected to an external meter);

Net Mode: Not selected by default;

Ground Detection: select ON;

PEN Protection: select ON;

TLS Encryption: Select ON.

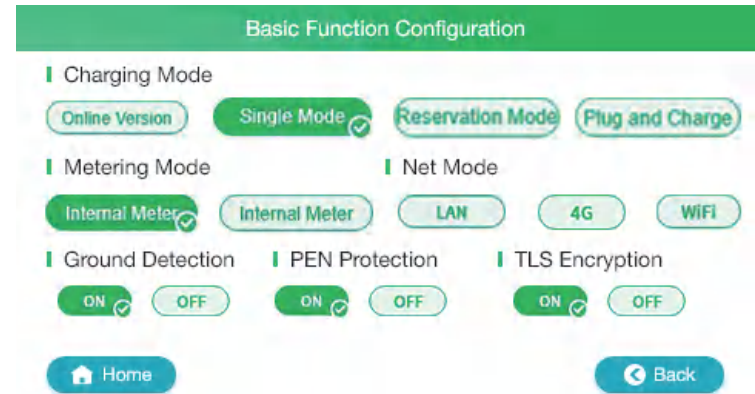

In the standalone charging mode, it is necessary to bind a card or set a key in the Card Management System interface (the charging pile must be consistent with the charging card key). If the card is already bound, only the bound card can be used for charging. If the card is not bound, the key card can be used for normal charging.

In the standalone mode, when the gun is plugged in, a charging QR code appears. After swiping the card, charging begins. Swiping the card again stops charging.

Key card making: Modify the key in Key, click OK, restart the charging pile, and then check whether the key is successfully modified on this interface. The key of the charging card needs to be set using our company's professional card making tool with the same key as the charging pile.

Suggestion:

Individual users should adopt the card-binding charging mode, while operators should adopt the key card-making charging mode.

Card Management System

NO.1 :

NO.2 :

NO.3 :

Key : -----

4.3 Reservation Mode

First, in the Basic Function Configuration interface, configure the following parameters, and then restart the charging pile (rebooting the device is required to modify the charging mode).

- Charging Mode: Reservation Mode;
- Metering Mode: Internal Meter (select when not connected to an external meter), External Meter (select when connected to an external meter);
- Net Mode: not selected by default;
- Ground Detection: select ON;
- PEN Protection: select ON;
- TLS Encryption: Select ON.

Basic Function Configuration

Charging Mode

Metering Mode
Net Mode

Ground Detection **PEN Protection** **TLS Encryption**

4.3.1 Starting charging

After the restart is complete, the four reservation methods displayed in the gun-inserted state are:

- By Power: By power
- By Amount: By Amount
- By Time: By time
- Scheduled Charging: Timed charging

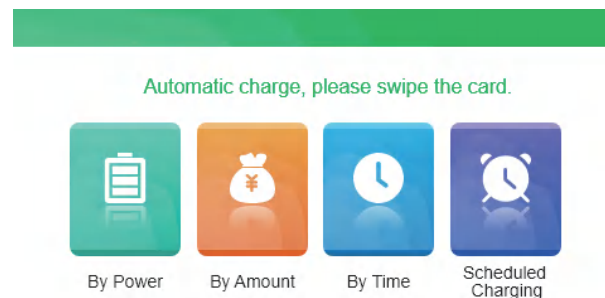

Select By Power and click Enter to display the Reservation Electricity interface. Enter the amount of electricity to be charged and click Confirm to display the QR code charging interface. Swipe your card to charge. As shown in the figure;

NOTE:

When using a card for charging in the reservation mode, it is necessary to bind the card or set a key in the Card Management System interface (the charging pile must be consistent with the charging card key). If the card has been bound, only the bound card can be used for charging. If the card has not been bound, the key card can be used for normal charging.



Select By Amount and click to display the Reservation Amount interface. Enter the amount to be charged and click Confirm to display the QR code charging interface. Swipe your card to charge. As shown in the figure;

NOTE:

To use a card for charging in the reservation mode, you need to bind the card or set a key in the Card Management System interface (the charging pile must be consistent with the charging card key). If the card is already bound, only the bound card can be used for charging. If the card is not bound, the key card can be used for normal charging.

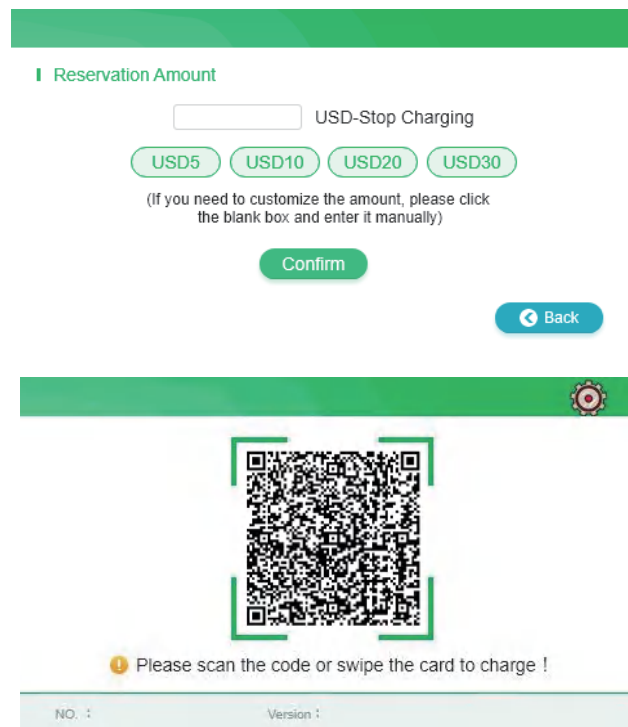

Select By Time and click Enter to display the Reservation Time interface. Enter the desired charging time and click Confirm to display the QR code charging interface. Swipe your card to charge. As shown in the figure;

NOTE:

To use a card for charging in the reservation mode, you need to bind the card or set a key in the Card Management System interface (the charging pile must be consistent with the charging card key). If the card is already bound, only the bound card can be used for charging. If the card is not bound, the key card can be used for normal charging.

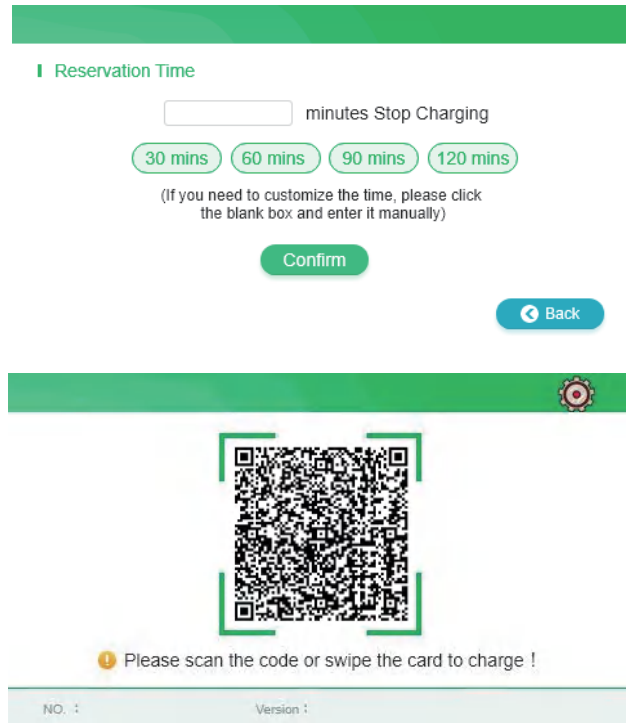

Select Scheduled Charging and click Enter to display the Scheduled Charging interface. Enter the time point and click Confirm to display the QR code charging interface. Swipe your card to charge. As shown in the figure;

NOTE:

Cards used for charging in the reservation mode need to be bound or set with a key in the Card Management System interface (the charging pile needs to be consistent with the charging card key). If the card is bound, only the bound card can be used for charging. If the card is not bound, the key card can be used for normal charging.



After swiping the card, the interface displays that charging is being scheduled, please do not unplug the gun. As shown in the figure; charging will automatically start at the scheduled time.

4.3.2 Stop charging

When charging reaches the value set during self-charging, the charging will automatically stop; or use the card swiped at the beginning of charging to stop charging in advance by swiping it again.

4.4 Plug and Charge

First, in the Basic Function Configuration interface, configure the following parameters, and then restart the charging pile (rebooting the device is required to modify the charging mode). The plug-and-charge mode allows charging by plugging in the gun, and stopping charging by unplugging the gun or stopping when fully charged.

Charging Mode: Plug and Charge;

Metering Mode: Internal Meter (without external meter connection), External Meter (with external meter connection);

Net Mode: Not selected by default;

Ground Detection: select ON;

PEN Protection: select ON;

TLS Encryption: Select ON.

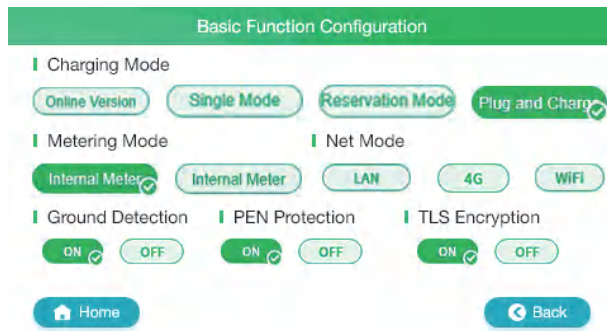

05

Common problems and solutions of charging pile

Use of
Charging Pile

◆ 1.The main reasons for slow charging may be insufficient power of the charging pile, charging current limit of the electric vehicle, and insufficient power supply of the parking space. Please choose a higher-power charging pile, check the vehicle settings to adjust charging parameters, choose another parking space, or report the power supply issue to the relevant department.

◆ 2.When using a charging pile, sometimes you may encounter charging failure and cannot charge normally. This may be due to a charging connector fault, charging pile fault, or charging card issue. Please check the connector for damage and ensure that the plug is firmly inserted. Contact the charging pile management unit for repair or replacement. Report the fault condition for repair or replacement.

◆ 3.The charging card may have poor contact, damage, or other issues that cause charging failure. If there is a problem, please replace the charging card or contact the issuing institution of the charging card in a timely manner to resolve the issue. When the charging pile system changes the charging mode, it should restart the power supply to verify that the mode change is successful before use.

◆ 4.During charging, it is not allowed to forcefully remove the charging connector, as doing so may cause sparks at the connector and result in safety accidents.

◆ 5.The charging ends or the charging ends abnormally, resulting in unsettled charges. Please swipe your card to settle the charges.

◆ 6.Please swipe the same card when charging starts and ends.

◆ 7.When installing the charging pile, the grounding line should be reliable and free of defects or ungrounded, otherwise it will not be able to charge.

◆ 8.If you need to stop charging in advance, please use the card to stop charging as usual.

◆ 9.If there is a safety accident during the charging process, such as abnormal sound, short circuit of wires, etc., please press the emergency stop button on the panel to disconnect all power supplies and immediately contact the on-site management personnel.

◆ 10.If the display screen is not working, restart the charging pile or contact a professional technician for repair.

◆ 11.If the charging cable, power supply, or interface is damaged, please contact a professional technician for repair and replacement, and conduct regular inspections.

◆ 12.If the gun head is damaged or there are foreign objects in the needle hole, check and clean it. Power off and restart the device every one or two months.

◆ 13.If the card is not working, restart the device, replace the card, and call customer service for advice.

◆ 14.Please switch off the power when the equipment is not used for a long time. Avoid touching the emergency stop button in non-emergency situations.